

PART 2

CANADIAN CADET MOVEMENT

AIR RIFLE TRAINING AIDE-MÉMOIRE

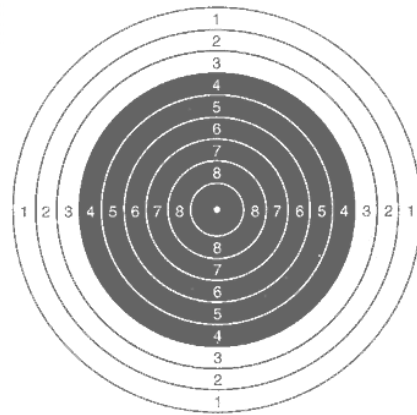
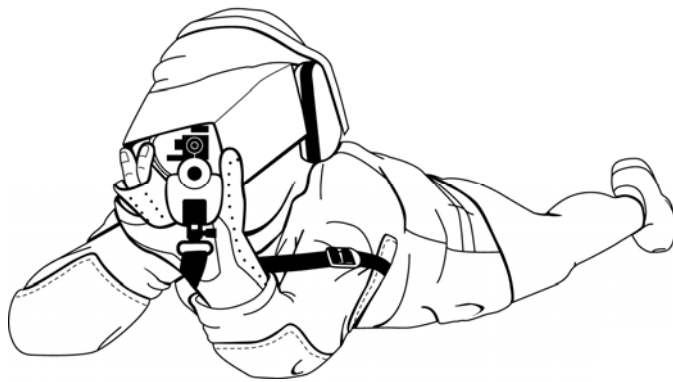

TABLE OF CONTENTS

	PAGE
PART 1 – AIR RIFLE TRAINING MANUAL	1-1-1/1-1-2
PART 2 – AIR RIFLE TRAINING AIDE-MÉMOIRE	2-1
General	2-1
Safety	2-2
Air Rifle Ranges	2-4
The Daisy 853C Air Rifle and Pellets	2-5
Proper Eye Usage	2-6
Prone Position	2-7
Standing Position	2-9
Kneeling Position	2-11
Aiming	2-13
Natural Alignment	2-14
Breathing	2-15
Trigger Control and Follow-through	2-16
Use of the Sling	2-17
Loading, Firing and Unloading the Air Rifle	2-18
Pumping the Air Rifle	2-19
Cleaning the Air Rifle	2-20
Immediate Action and Stoppages	2-21
Range Commands and Procedures	2-22
Marksmanship Equipment	2-23
Physical Training	2-25
Coaching	2-26
PART 3 – UNIT MARKSMANSHIP TRAINING PLAN	3-1
PART 4 – MARKSMANSHIP CHAMPIONSHIP SERIES	4-1-1/4-1-2

PART 2

AIR RIFLE TRAINING AIDE-MÉMOIRE

GENERAL

The purpose of this aide-mémoire is to provide corps, squadrons and Cadet Summer Training Centres with a simple guide to essential marksmanship knowledge and skills. It has been formatted to be easily distributed in the form of handouts. The information found in this document is derived from the Air Rifle Training Manual, which should still be consulted for in-dept reference on any marksmanship subject.

This manual does not take precedence over any Cadet Administrative Training Order (CATO), Canadian Forces Technical Order (CFTO), Canadian Forces Administrative Order (CFAO), or any other Department of National Defence (DND) regulation or order.

When an item refers to a right-handed marksman, the reverse of that item refers to a left-handed marksman.

References to the directions left and right are described from the perspective of a marksman that is in the firing position.

Suggestions for improvements to this document are encouraged and may be submitted to the Staff Officer responsible for marksmanship within each Area/Region.

SAFETY

Firearms safety is the number one priority on and off the range so everyone must do their part to prevent accidents. In this sport, the majority of incidents are caused by the ignorance of proper rifle operating procedures or by mishandling.

SAFETY CATCH

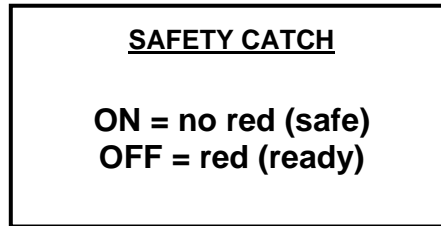

SAFETY ROD

To ensure that air rifles are not removed from the firing point or stored with a pellet in the chamber or barrel, a safety rod is to be inserted in the barrel from the muzzle end.

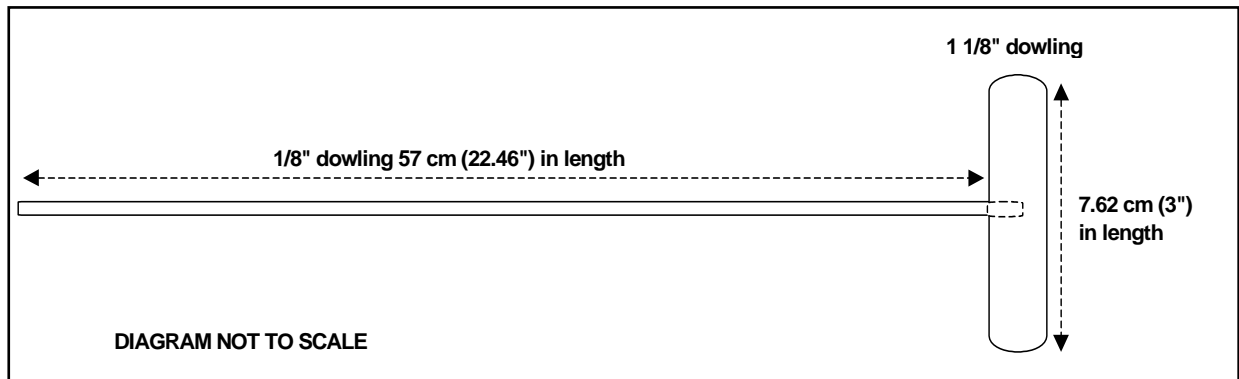

SAFE RIFLE STATUS

When not being handled on the range or in a training environment, the air rifle must be in a safe status. The following options denote various "safe rifle status".

<p>Option One In the rifle case</p> <p>Safety catch is ON Bolt is forward Action is not cocked Safety rod is in the case Pump lever is partially open</p>	<p>Option Two On the firing line</p> <p>Safety catch is ON Bolt is to the rear Pump lever is partially open</p>	<p>Option Three Not on the firing line</p> <p>Safety catch is ON Bolt is to the rear Safety rod is in barrel Pump lever is partially open</p>
---	---	---

REMOVING A RIFLE FROM THE CASE

The rifle case should be clearly marked on the outside with an arrow, indicating in what direction the rifle inside is pointing. This will ensure that when the case is opened, the rifle is pointing in a safe direction. The rifle must be in a safe status when removed from its case.

INDIVIDUAL SAFETY PRECAUTIONS

Upon receiving a rifle or when the “safe rifle status” is uncertain, individual safety precautions should be done to confirm that the rifle is safe. An individual must ensure that:

- a. The bolt is open fully to the rear;
- b. The safety catch is in the ON position;
- c. The pump lever is partially open; and
- d. A safety rod is inserted in the barrel.

SAFETY REGULATIONS

Safety regulations are all common sense and are easy to apply when people understand why they are necessary to help prevent accidents.

The following is a list of essential safety regulations:

- a. A rifle should always be treated as if it is loaded and be considered dangerous unless proven otherwise;
- b. A rifle should never be pointed at anyone;
- c. A rifle should always point in a safe direction;
- d. A rifle should be held in the vertical position with the muzzle pointing up when transporting it;
- e. Fingers should be kept off the trigger unless the marksman is ready to fire;
- f. Hearing protectors may be worn; and
- g. The wearing of safety glasses or shatterproof eyeglasses is mandatory when firing.

DISPOSAL OF LEAD PELLETS AND PERSONAL HYGIENE

Each time someone handles pellets, a small trace of lead is left on their hands and can be transferred to other parts of their body or to food. Over a period of time, this contact could increase lead levels in the body. It is therefore recommended that hands be washed thoroughly following all contact with pellets.



Spent pellets are regarded as hazardous waste and must be disposed of in accordance with local regulations.

AIR RIFLE RANGES

The marksmanship CATO, specifically the annexes on Ranges and Security should be consulted for all the technical details relevant to this subject.

Air rifles may only be fired on a properly prepared air rifle range. The principal dangers found on an air rifle range are:

- a. The ricochet of pellets after they strike a reflecting surface; and
- b. Improper firearms handling.

It is the responsibility of the RSO to ensure that the range is safe and meets all range requirements. It is essential that no part of the pellet stop area may cause a pellet to ricochet.

ITEMS REQUIRED TO SET UP AN AIR RIFLE RANGE

- a. Area 15 metres long with controlled access;
- b. Numbered target backstops and firing lanes;
- c. Flags (red and green);
- d. First aid kit and stretcher;
- e. Appropriate mats;
- f. Spotting scopes;
- g. Hearing protectors;
- h. Safety glasses;
- i. Targets;
- j. Pellets; and
- k. Hand washing facility.

RANGE MAINTENANCE

The range must be cleaned after each use and the lead disposed of as contaminated waste. The pellet stop must be inspected regularly to ensure that deterioration has not occurred.

THE DAISY 853C AIR RIFLE AND PELLETS

CHARACTERISTICS

These are the main characteristics and parts of the Daisy 853C air rifle and the pellets used with this rifle:

- a. **Action** – single pump pneumatic, straight pull-bolt;
- b. **Length** – 97.8 cm;
- c. **Weight** – 2.5 kg;
- d. **Calibre** – 0.177" calibre (4.5 mm);
- e. **Front sight** – Global type with interchangeable aperture inserts;
- f. **Rear sight** – Fully adjustable peep rear sight with micrometer click adjustment;
- g. **Muzzle velocity** – 150.8 metres per second;
- h. **Loading** – Single or auto indexing five (5) pellet clip; and
- i. **Stock** – Full-length, sporter-styled hardwood with adjustable length.

PARTS

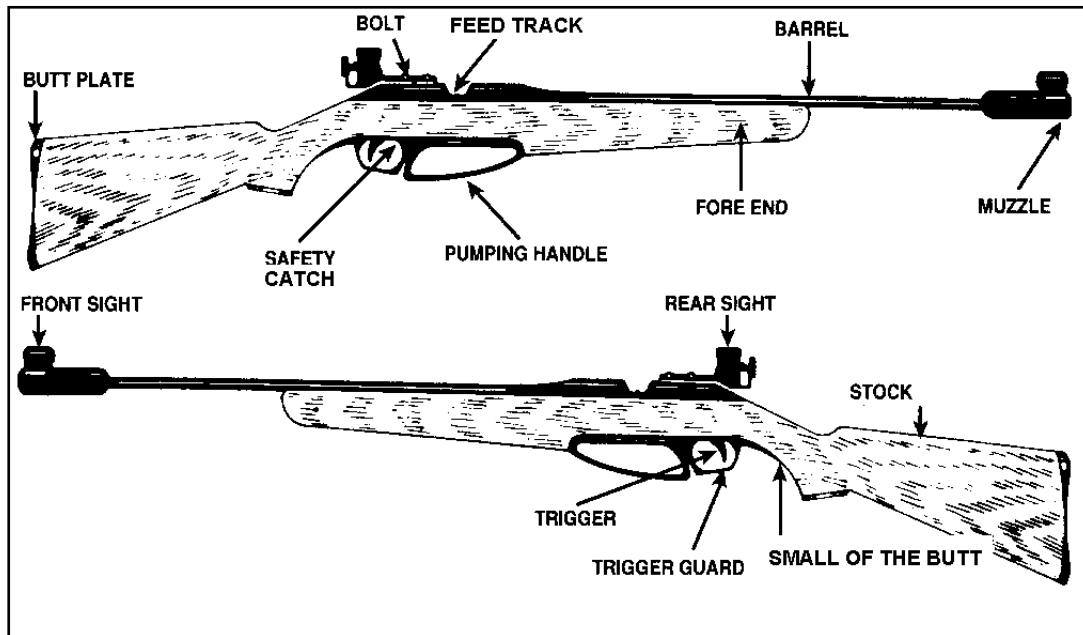

AIR RIFLE PELLETS

The most popular pellet design is the hourglass-shaped air rifle pellet, commonly referred to as the diabolo. There are a number of variations on the basic diabolo design. For marksmanship and competition training, the wadcutter pellet is used. This flatheaded pellet is designed for cutting neat, clean holes in paper, which allows for accurate, precise scoring of the target.

PROPER EYE USAGE

The master eye must be determined before individuals begin firing. It should be noted that the master eye is not always on the same side of the body as the writing hand.

SELECTING THE MASTER EYE

Everyone has a master (or dominant) eye which is stronger than the other one. This is the eye to be used when aiming. If the master eye is on the opposite side of the body than the writing hand, it is advisable to change shoulders and fire with the opposite hand and use the master eye. This should not however, be done at the expense of comfort.

NOTE

If changing shoulders in order to accommodate the master eye proves uncomfortable, cadets should fire the way they feel most comfortable.

To determine the master eye, the steps listed below should be followed:

- a. Select a small object (i.e., the corner of a wall) at least five metres away;
- b. Face the object and extend both arms in front of the body towards the object;
- c. With both eyes open, form a small, tight opening around the object with the thumbs and index fingers;
- d. Look at the object through the opening with both eyes open and draw both hands back toward the face. Ensure that the object remains centred through the opening of the thumbs and index fingers; and
- e. The person should now be looking through the opening at the object with one single eye – the stronger of the two. This is the master eye that should always be used for aiming.

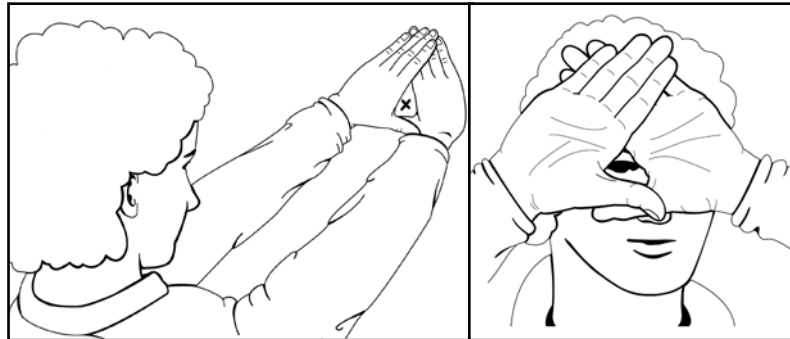

FIRING WITH BOTH EYES OPEN

Cadets should always fire with both eyes open. Eyes are constantly working together. If cadets have difficulty focusing, the use of a blinder in front of the non-aiming eye will help prevent squinting and eye fatigue.

Cutting a piece of plastic from a windshield washer fluid jug or any other similar type of container can easily make a blinder. A good blinder should be translucent (plastic or paper) so that images are blocked even though light can penetrate it. It should be easily attachable to the rear sight or to the cadet's glasses.

PRONE POSITION

Obtaining a good prone position is one of the most, if not the most important principle of marksmanship. Although an excellent position will not guarantee an excellent performance, a poor position can almost assure a substantially negative effect on results.

OBJECTIVES OF A GOOD POSITION

The position should be:

- a. Natural;
- b. Without strain;
- c. Comfortable;
- d. Stable;
- e. As such that body weight is equally distributed; and
- f. Consistent throughout the relay.

CHARACTERISTICS OF A GOOD POSITION

- a. The body should form a 5-20° angle to the line of sight;
- b. The body should not be twisted and the spine should be straight;
- c. The left leg should be parallel with the spine;

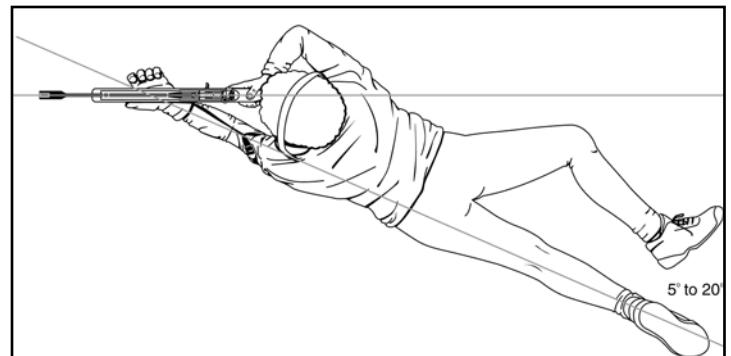

- d. The right foot should turn out and point to the right; the left foot should be straight behind on the toe or pointed to the right according to the comfort of the individual;
- e. The right knee should be brought up so that the thigh forms an angle between 30-45° with the left leg. The right knee should be bent in order to improve stability;

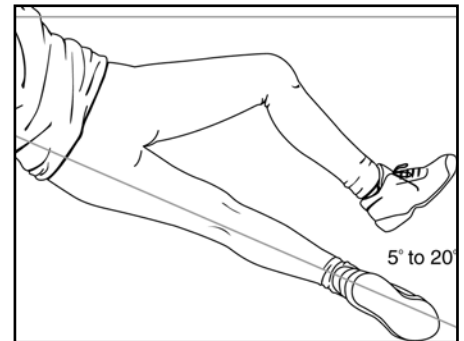

- f. The left elbow should be positioned slightly to the left of the rifle. In order to maintain consistency throughout the relay, the left elbow should not be moved, even while pumping the rifle;
- g. The left forearm should form at least an angle of 30° with the ground;



- h. The left hand should rest in the sling and firmly against the sling swivel and the fingers should not grip the fore end of the stock;

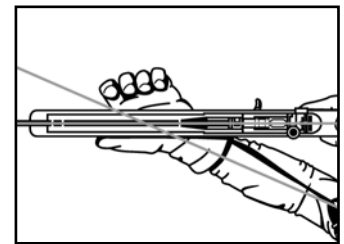

- i. Once a good position is established, the right hand should grip the small of the butt with constant pressure;
- j. The right thumb should be placed on the stock directly behind the rear sight;
- k. The position of the right elbow is established after the rest of the body is in place. After placing the right hand on the small of the butt, the right elbow should rest naturally where it falls and feels comfortable;

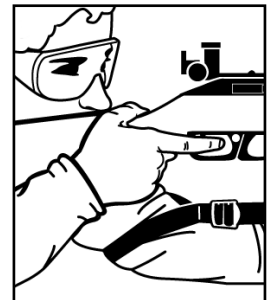

- l. The shoulders should be straight and form right angles with the spine;
- m. The butt plate is kept firmly in the hollow of the right shoulder; and
- n. The head rests comfortably on the butt and remains straight.



STANDING POSITION

The standing position has the smallest area of support of all firing positions, thus it is the most difficult to hold steady. Cadets must come to grips with the fact that when firing in the standing position, they may never achieve complete immobility.

The standing position should be: natural, without strain, comfortable, stable, balanced in such a way that body weight is equally distributed, and consistent throughout the relay.

CENTRE OF GRAVITY

The centre of gravity is the point where the weight of the rifle and the cadet's body weight are evenly distributed between the feet. In order to compensate for the weight of the rifle, the cadet's back is bent to the right and rearward in order to gain bone support and stability.

If the cadet stands straight, the weight of the rifle will pull the body to the front. Muscle strain will appear in the back as the cadet attempts to keep their body from falling forward. By bending back and to the right, a shift in body weight will occur slightly towards the right foot. At a certain point, the weight of the body on the right foot will equal the weight on the left foot. The body-rifle combination then reaches a state of balance, with the centre of gravity located between the cadet's two feet.

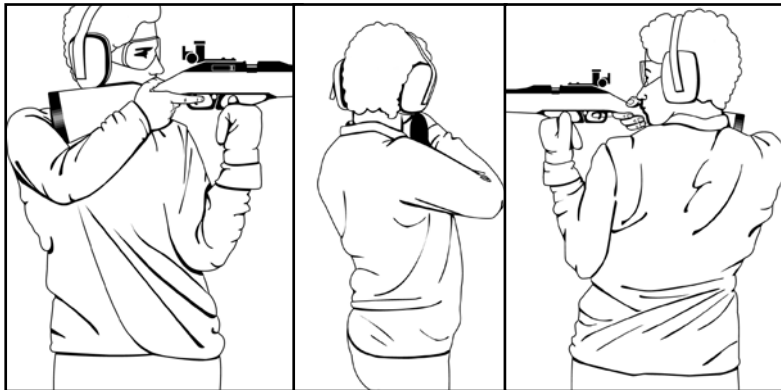
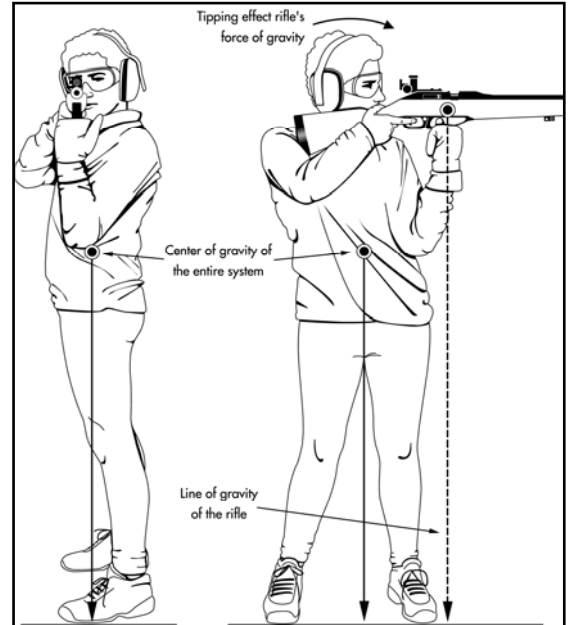

The combination of back bend and body twist is the most important feature of the standing position and will contribute significantly to the cadet's level of performance. However, cadets should understand that discomfort is common during the first few practice sessions. After a short period of time, however, this discomfort will diminish and an increasingly stable hold will be achieved.

CHARACTERISTICS OF A GOOD POSITION

- a. The body should face to the right, approximately 90 degrees to the target;
- b. The feet should be shoulder width apart and cadets should try to stand on the firmest surface possible;
- c. The feet should point straight ahead or could be turned slightly outward for comfort;
- d. The legs should be straight but not locked;
- e. The hips should be 90 degrees to the target and should not thrust forward;
- f. The left arm should rest against the rib cage. The left elbow should almost be directly under the rifle. Muscles should not be used to support the left arm;
- g. The left hand is used to support the rifle and should be positioned just forward of the trigger guard. There are several ways of holding the rifle, such as:

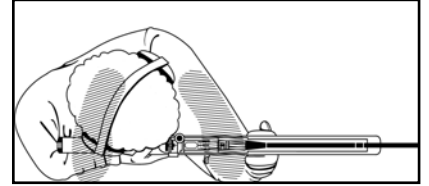

Clenched fist



V Shape



Split fingers



Heel of the hand

- h. The right hand should be comfortable and the right arm should drop naturally to the side;
- i. The head should be in an upright position with your eyes looking forward through the rear sight. To prevent involuntary body sway as a result of the balance mechanism in the inner ear, the head should remain straight and upright. The stock should rest high in the shoulder pocket bringing the sights up to eye level to keep from tipping the head forward to aim; and
- j. Eye relief distance should be between 5-15 cm and should usually be slightly greater than in the prone position.

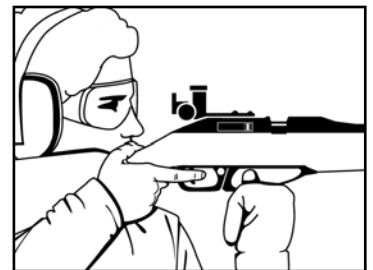

KNEELING POSITION

The kneeling position is the least comfortable of all the positions and requires substantial practice in order to master. Once the kneeling position is refined, scores and performances can match those of the prone position.

The kneeling position is a very stable position similar to the prone position, except achieving a comfortable position which is stable and minimizes movement is more difficult to achieve. The kneeling position is characterized by most firers as the least comfortable position and the most difficult to adopt correctly.

The kneeling position uses a rifle sling and contacts the floor at three points: the kneeling roll and foot combination, the right knee, and the left foot. A correctly adopted kneeling position, combined with practice will result in stability and results similar to the prone position.



A kneeling roll is a piece of equipment that many firers find improve the stability and comfort of the kneeling position. The main function of the kneeling roll is to provide support under the right foot. The kneeling roll is not always required especially with very flexible cadets.



The kneeling roll can be made from various materials like canvas, cotton, or other flexible materials and filled with material. Materials used to fill the kneeling roll can be dry beans, small plastic beads, wood chips, or other similar materials.

CHARACTERISTICS OF A GOOD POSITION

- The body should face 30° to 60° to the target, with the left leg pointed in the direction of the target;
- The kneeling roll should be placed at the same angle to the target as the right leg. The kneeling roll should be form fitted to the shooters foot during the preparation stage;
- The left foot and kneeling roll will form a straight line to the target;
- The right knee is placed on the floor at 30° to 60° to the body with the right foot sitting comfortably into the kneeling roll. Approximately 20% of the body weight is supported by the right knee;
- The right heel sits as close to the centre of the buttocks as possible. The right shoe tip sits comfortably on the floor. This combination supports a significant portion of the cadet's weight and this weight is transferred down the spine, into the foot and finally into the kneeling roll. Approximately 40% of the body weight is supported by the kneeling roll and right foot;
- The sling is attached to the rifle and the left elbow sits firmly upon the left knee. The combination of the sling, left elbow and rifle form a load-bearing triangle;

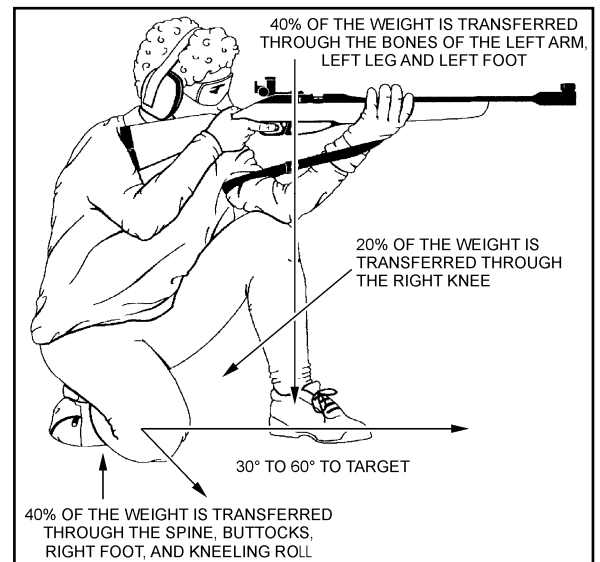

- g. The left hand rests in the sling and firmly against the sling swivel. The fingers of the left hand should not grip the fore-end of the stock. The hand should be relaxed and the rifle should rest in the palm of the hand;
- h. The placement and subtle position changes of the left foot regulate the natural alignment of the position. Altering the location, angle, and position of the left foot, changes in height and right/left direction can be achieved;
- i. The rifle is placed into the right shoulder and the upper body leans against the rifle, which is held into position with the rifle sling;
- j. The left leg from the knee to the floor is at a 70° to 90° angle to the floor. The left foot is turned towards the right side of the body to improve stability of the left leg. Approximately 40% of the body weight is supported by the left leg;
- k. The shoulders should be straight and form right angles with the spine;
- l. The butt plate is kept firmly in the hollow of the right shoulder;
- m. The head rests comfortably on the cheek piece and remains straight and level. The eye relief should be 5 to 15 cm. This distance should remain constant throughout the relay. When the face is placed on the cheek piece, the cadet should be looking directly through the sights; and
- n. The right arm should fall comfortably and naturally to the side of the body and the right hand should be placed upon the small of the butt. The right hand should be comfortable and under no strain. The trigger finger should not touch the stock. The position should allow the right hand, when placed on the small of the butt, to produce a straight back trigger pull.

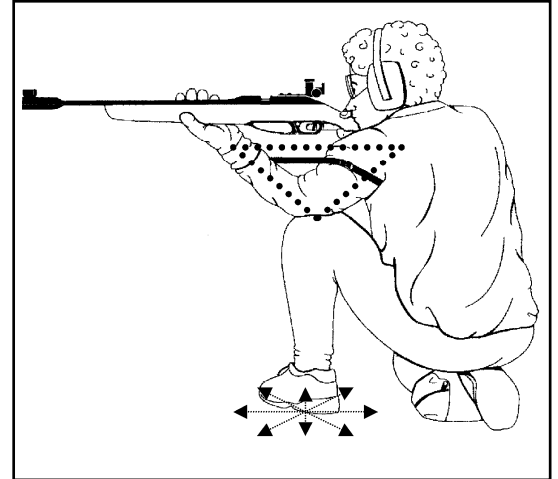

The position and weight distribution of the left leg, right knee, right foot and kneeling roll must remain the same. The head must be levelled and exert the same amount of pressure on the cheek piece, the eye relief must remain constant and the right hand must always be in the same position. If any of these points do not feel right or if the cadet finds the position uncomfortable, the position should be adjusted until the condition is improved.



AIMING

Cadets must constantly strive to maintain proper sight alignment, while obtaining a sight picture. It is the most critical element of the aiming process.

FRONT SIGHT

The front aperture should be selected to provide the best sight picture. A good sized aperture should appear 1 ½ times bigger than the aiming mark.

REAR SIGHT

The adjustment of the knobs is measured in clicks that can be felt as the knob is turned. It takes three clicks to move the point of impact approximately one pellet width.

- Elevation.** To lower the point of impact, turn the elevation knob counterclockwise (to the left). To raise the point of impact, turn the elevation knob clockwise (to the right), as per the arrow and the word "UP".
- Windage.** To move the point of impact to the left, turn the windage knob counterclockwise (to the left). To move the point of impact to the right, turn the windage knob clockwise (to the right), as per the arrow and the letter "R".

REMEMBER: SIGHT ADJUSTMENT

**UP & RIGHT = clockwise
DOWN & LEFT = counterclockwise**

EYE RELIEF

Eye relief is the distance between the eye and the rear sight. Depending on an individual's build and position, this distance is usually 5 to 15 cm. It is important for them to maintain the same eye relief from shot to shot and to find an eye relief that allows them to keep their head as erect as possible during the firing process.

SIGHT ALIGNMENT

Sight alignment is the most critical element of the aiming process. It is the alignment of the eye, the rear sight, and the front sight.

Proper sight alignment is a matter of centering the front sight hood in the rear sight. The hood will not quite fill the rear sight and cadets will be able to see light around the outside of the hood; we call this a "line of white."

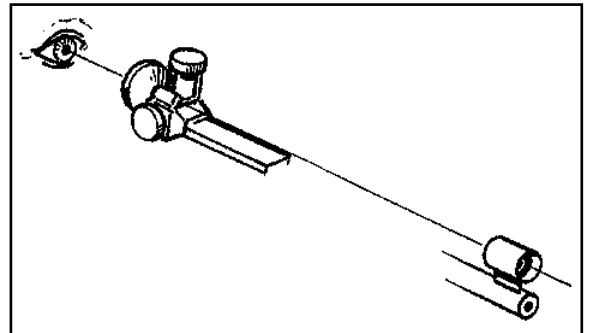

SIGHT PICTURE

To obtain a proper sight picture, a bullseye is simply added to the innermost ring. The goal during the aiming process is to maintain proper sight alignment while keeping the bull centered in the front sight.

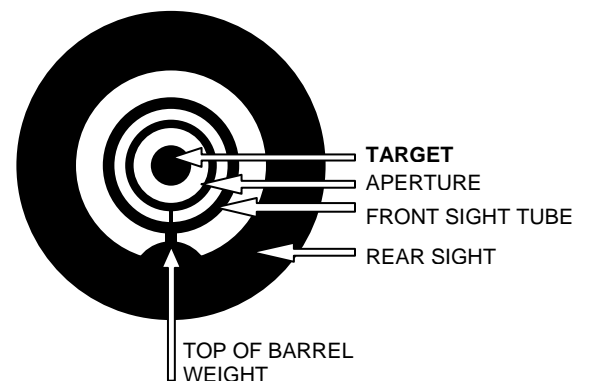

NATURAL ALIGNMENT

It is essential that cadets use their bones to support the rifle, so that their muscles remain relaxed. Under no circumstances should they use their muscles to change the point of aim by moving the rifle from side to side.

Natural alignment is obtained when the rifle can be perfectly aimed at the target without being muscled into achieving this. In a comfortable position, the cadet does not force the air rifle to point to the target, which would create muscular tension.

After establishing a comfortable position, the cadet must now make sure that their body and rifle are directly aligned with the target. In order to ensure that the position is directly in line with the target, cadets should follow these steps:

- a. Assume the prone position, look through the sights and acquire a proper sight picture;
- b. Close their eyes, take several normal breaths and relax into a comfortable position;
- c. Once comfortable, look through the sights again. If they are perfectly centred with the target, proceed with firing;
- d. If they are not directly centred with the target, they will need to re-orient their position slightly. To do this, they will need to pivot their body on their left elbow, more precisely:
 - (1) If they are aiming too far to the left, move the lower body slightly to the left;
 - (2) If they are aiming too far to the right, move the lower body slightly to the right;
 - (3) If they are aiming too low, move the lower body slightly back (if this does not work, they can tighten the sling); and
 - (4) If they are aiming too high, move the lower body slightly forward (if this does not work, they can loosen the sling); and
- e. Close their eyes and do a final check on their alignment. If they are still not perfectly aligned, they must start over! They must remember to never move their left elbow when they shift their position around.

BREATHING

Cadets should use breathing as a way to confirm that the rifle is moving up and down in a perfect vertical manner and that the rifle is not canted. Also, when breathing in and out, cadets can visually confirm that they are aiming on the proper diagram.

IMPORTANCE OF BREATHING

While breathing, the oxygen inhaled is used to supply muscles with energy, ensuring optimal potential of these muscles. This includes the muscles that are involved in the position, as well as the muscles in the eyes. For maximum stability when firing, cadets will have to stop breathing for a few seconds. It is of the utmost importance that they do not hold their breath for more than five to seven seconds, as the tension will increase in their chest muscles and reduce stability.

THE BREATHING CYCLE

In order to achieve a proper breathing sequence, the information in the following graph should be adhered to:

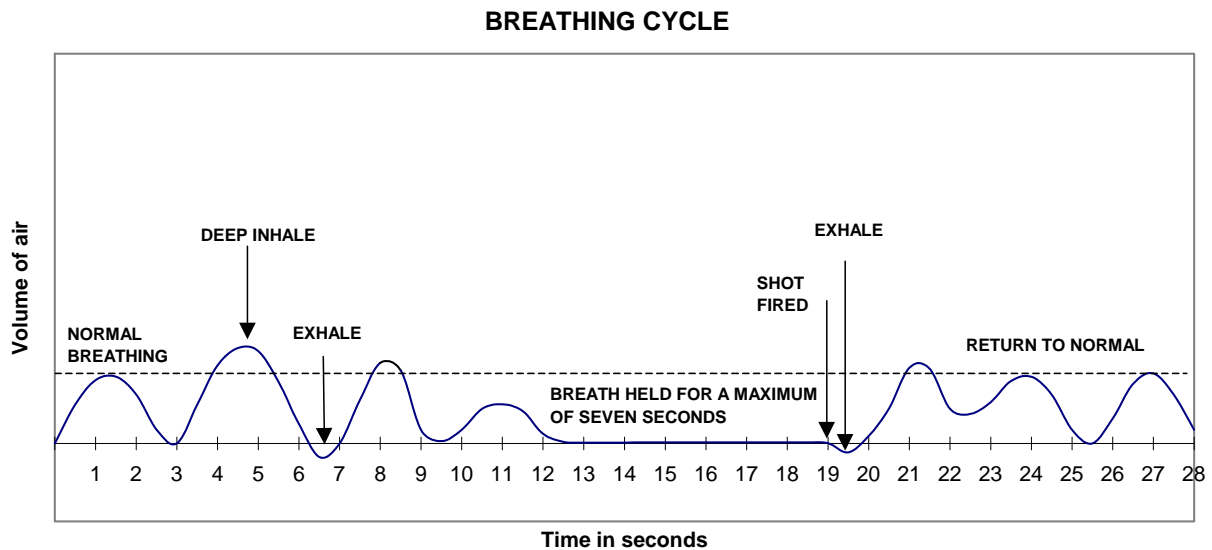

Again, it is important for cadets not to fire if they feel they want to breathe again. Their shot will not be perfect and their end result will be affected.

TRIGGER CONTROL AND FOLLOW-THROUGH

Trigger control is the manipulation of the trigger in such a way that there is no disturbance or motion of the foresight. It must be constant, controlled, slow and deliberate. Consistent squeezing of the trigger assures the desired trajectory upon the departure of the pellet.

POSITION OF THE HAND ON THE RIFLE

Cadets should have a relatively firm grip on the small of the butt with the bottom three fingers of their hand. The thumb should point forward and rest in a relaxed position behind the rear sight along the rifle stock or should be wrapped around the small of the butt.

TRIGGER FINGER POSITION

The index finger should be placed on the trigger halfway between the tip of the finger and the first joint. The index finger never touches the stock of the rifle and must be vertically centered on the trigger.

SQUEEZING THE TRIGGER

Trigger pressure should only be applied when the cadet is ready to fire. It must be applied straight to the rear by bending the second joint of the index finger. Cadets should make sure the pressure they apply is constant and that they slowly squeeze the trigger while they are holding their breath.

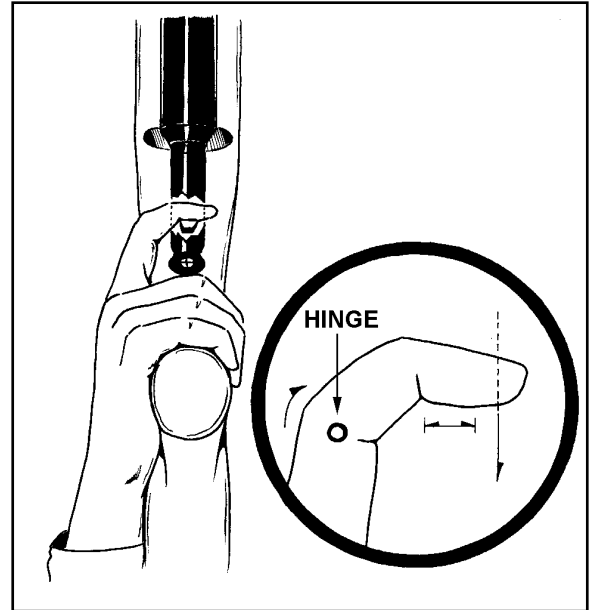

FOLLOW-THROUGH

Follow-through is defined as the act of remaining in position for a few seconds after the pellet's departure and it requires both physical and mental effort. It aids in developing proper hold of the rifle, maintaining stability, ensuring that there is no movement of the rifle as the shot is being fired, and calling the shot after it is fired.

When done properly, it permits the cadet to call their shot with extreme accuracy and ensures consistency during the firing session. This becomes particularly important when trying to improve performance or correct faults. If the position is stable, the aiming picture should return to the same place it was before the vibrations caused by the release of compressed air.

USE OF THE SLING

The sling provides maximum support of the rifle with the least amount of physical effort on the part of the individual.

ASSEMBLING THE SLING

To assemble the sling, follow the steps listed below:

- a. Hold the sling parallel to the ground with the short section in the left hand, ensuring that the rounded tip of the top buckle is pointing left;
- b. Take the short section, loop it up through the middle slot of the metallic clasp and then back down through the front slot (nearest the rounded tip). The short section will now form a circle; and
- c. Turn the sling over and slide the sling swivel onto the long section. Ensure the sling swivel hangs downwards, as it will later attach to the rifle. Loop the long section up through the middle slot and then back down through the front slot. It is now important to take the remaining end and loop it back through the rear slot, locking the sling in place. This will ensure that the sling will not come undone or loosen during firing.

POSITION OF THE SLING ON THE ARM

The sling should be positioned on the upper left arm above the biceps near the shoulder. This is the area on the arm where the smallest amount of pulse can be felt. The sling should never be twisted.

ATTACHMENT OF THE SLING TO THE RIFLE

The sling should be attached to the rifle using its hook. To attach the sling, the hook on the sling should be opened by pressing on its side screw. The hook pin should be slipped into the attachment clamp on the rifle's sling swivel and the hook should be screwed over the pin to ensure it will not fall out.

ADJUSTMENT OF THE SLING

If the sling is too loose it will no longer act as a method of support and the cadet will hold the rifle using their muscles. If the sling is too tight, blood flow will be restricted and cause a more pronounced pulse, which will have a negative effect on the cadet's hold.

LOADING, FIRING AND UNLOADING THE AIR RIFLE

These steps should be adhered to in order to safely fire the Daisy 853C air rifle.

LOADING THE AIR RIFLE

The following steps should be followed when loading the rifle:

- a. Pick up and hold the rifle with the left hand;
- b. Ensure the safety catch is in the ON position;
- c. Place the sling on the rifle;
- d. Pump the rifle;
- e. When the pump handle is fully extended, pause for about three seconds;
- f. Bring the pump lever back to the closed position;
- g. Load a pellet or a five (5) pellet clip; and
- h. Close the bolt.

FIRING THE AIR RIFLE

The following actions should be performed in order to fire the rifle:

- a. Place the safety catch in the OFF position;
- b. Aim the rifle at the target;
- c. Squeeze the trigger;
- d. Open the bolt, pump the rifle, reload, aim and fire;
- e. Repeat the last step until the firing is done;
- f. Upon completion, open the bolt, place the safety catch in the ON position and partially open the pump lever; and
- g. Lay the rifle down.

UNLOADING THE AIR RIFLE AND PREPARING FOR INSPECTION

These steps should be followed when unloading the rifle:

- a. Pick up the rifle;
- b. Remove the five (5) pellet clip (if used);
- c. Pump the rifle;
- d. Move the bolt forward (do not insert a pellet);
- e. Place the safety catch in the OFF position;
- f. Aim the rifle at the target;
- g. Squeeze the trigger;
- h. Open the bolt;
- i. Place the safety catch in the ON position;
- j. Open the pump lever slightly;
- k. Place the rifle on the shoulder, muzzle pointed down range;
- l. Wait to be cleared by the RSO; and
- m. Lay the rifle down.

PUMPING THE AIR RIFLE

Even though this method may seem quite awkward, any cadet can easily perform it.

To pump the rifle, the cadet should follow these steps:

- a. Remove the butt from the shoulder and rest it on the mat;
- b. Partially open the pump lever with the right hand;
- c. Return the right hand to the small of the butt;
- d. Grasp the pump lever with the left hand, halfway up the lever;
- e. Lift the rifle upwards until the pump lever is fully extended (keep the left elbow on the mat);
- f. Pause for three seconds when the pump lever is fully extended;
- g. Bring the rifle down, thereby returning the pump lever to the closed position;
- h. Load the pellet or the five (5) pellet clip; and
- i. Move the bolt forward.

Prone Position

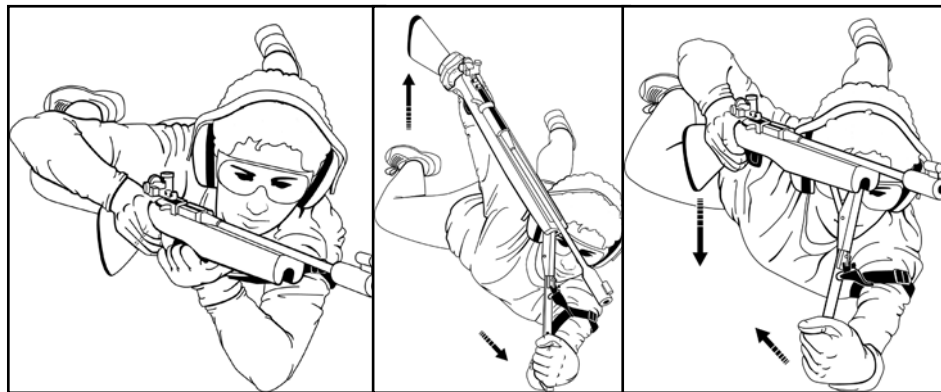

Kneeling Position



CLEANING THE AIR RIFLE

No one should attempt to clean a rifle until individual safety precautions have been performed on the rifle and it is certain that the barrel is clear of any obstructions.

CLEANING THE BORE

When	Action
Before firing	Fire 2-3 felt cleaning pellets.
After firing	Fire 2-3 felt cleaning pellets.
Periodic	Fire a felt cleaning pellet soaked in SAE 30 motor oil; Wait 5 minutes; and Fire 3 felt cleaning pellets.
Storage of three months or longer	Fire 2-3 felt cleaning pellets; Fire one felt cleaning pellet soaked in SAE 30 motor oil; and Fire 3 felt cleaning pellets when taking rifle out of storage.

CLEANING OF OTHER PARTS

- a. **Stock.** The stock should be frequently wiped clean with a damp cloth;
- b. **Metallic Parts.** The exterior metallic parts of the rifle should be cleaned on a regular basis with the aid of a lightly oiled flannel patch; and
- c. **Pivot Points.** The pivot points should also be lightly lubricated on a regular basis.

IMMEDIATE ACTION AND STOPPAGES

When a problem occurs, the cadet must point the rifle down range at all times and notify the RSO.

PROBLEM	SOLUTION
Pellet incorrectly seated in chamber	Place the safety catch in the ON position; Open the bolt fully to the rear; and RSO will insert a safety rod in the barrel to clear the pellet.
Pellet stuck in barrel	Place the safety catch in the ON position; Open the bolt fully to the rear; and RSO will insert a safety rod in the barrel to clear the pellet.
Two pellets lodged in the barrel or chamber	Attempt twice to fire the pellets out. If unsuccessful: <ol style="list-style-type: none"> a. Place the safety catch in the ON position; b. Open the bolt fully to the rear; and c. RSO will insert a safety rod in the barrel to clear the pellet.
Rifle does not fire	Conduct a functioning test: <ol style="list-style-type: none"> a. Place the safety catch in the ON position; b. Open the bolt fully to the rear; c. Close the bolt; d. Place the safety catch in the OFF position; and e. Squeeze the trigger. <p>If the rifle still does not fire, conduct a pumping functioning test:</p> <ol style="list-style-type: none"> a. Place the safety catch in the ON position; b. Open the bolt fully to the rear; c. Pump the rifle; d. Close the bolt; e. Place the safety catch in the OFF position; and f. Squeeze the trigger. <p>If the rifle still does not fire, clear the rifle:</p> <ol style="list-style-type: none"> a. Place the safety catch in the ON position; b. Open the bolt fully to the rear and partially open the pump lever; and c. RSO will insert a safety rod in the barrel to clear the pellet.

RANGE COMMANDS AND PROCEDURES

The following range commands will be given by the RSO and must be learned by cadets before they fire on a range.

COMMAND	ACTION
Cover off your firing point	Stand up, move behind the firing point and await further commands.
Place your equipment down and stand back	Lay the equipment down on the mat and stand back when finished.
Adopt the prone position	Adopt the prone position, pick up the rifle, ready the equipment and put on the hearing and eye protection.
Type of firing	This command includes information about the range and type of firing. i.e., Relay No. __, 10 metres, five rounds, Grouping, On Your Own Time...
Relay, load, commence firing	Ensure the safety catch is in the ON position; Pump the rifle; When the pump lever is fully extended, pause for about three seconds; Load the pellet; Close the bolt; Place the safety catch in the OFF position; Aim the rifle at the target; Squeeze the trigger; Open the bolt; Repeat the sequence for each shot; Place the safety catch in the ON position and partially open the pump; lever immediately after firing the practice; and Lay down the rifle.
MAY BE GIVEN	
Relay, cease fire	Stop firing, put the safety catch in the ON position and lay the rifle down.
Relay, resume fire	Put the safety in the OFF position and continue the practice.
Relay, unload and prepare for inspection	Pick up the rifle; Remove the five (5) pellet clip if used; Pump the rifle; Close the bolt; Place the safety catch in the OFF position; Aim rifle at target; Pull the trigger; Open the bolt; Place safety catch in the ON position; Open the pump lever 5-8 cm; Place the rifle on the shoulder, muzzle pointed down range; Wait to be cleared by the RSO; Lay the rifle down; and Remove hearing and eye protection.
Relay, stand up	Stand up and leave the equipment on the ground.
Change targets	Move forward, walk down the lane to remove old targets and replace them with new ones. Return to the firing point.
Change relays	Cadets who have just fired pick up their personal equipment and move of the firing point. The new relay covers off behind the firing point.

MARKSMANSHIP EQUIPMENT

Cadets performance can be easily improved by providing them with adequate apparel. This apparel will help to increase both stability and comfort.

MARKSMANSHIP JACKET

A jacket offers some support and helps stabilize the body. Rubber pads are attached to the elbows and to the right shoulder to soften contact with the ground and with the rifle. The jacket must be large enough to permit the wearing of sweaters.

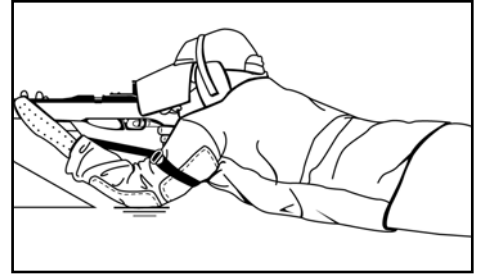

MARKSMANSHIP GLOVE

The marksman's glove protects the back or interior of the hand against pressures created by the sling and the sling swivel.

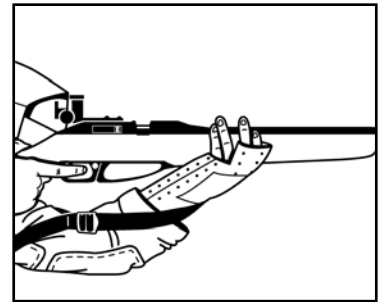

MARKSMANSHIP HAT

The marksman's hat has flap sides and an elongated peak, which creates a tunnel vision and helps in avoiding neighbouring distractions.



SWEATERS

It is of the utmost importance to wear at least one sweater under the marksman's jacket. If possible, two sweaters should be worn. These sweaters increase stability and absorb pulse beat.

TELESCOPE

Telescopes are used so that the cadet or coach can view the target and make sight adjustments based on the fired shots.

MATS

Mats or ground sheets are used to aid the comfort of the cadets. However, they may not be used to provide an artificial support.

TABLE, CHAIRS OR ADJUSTABLE DEVICE

Tables, chairs or adjustable devices are used in the standing and kneeling positions. These aids are used to ensure all equipment (scope, tools, inserts, etc.), pellets and targets are close enough to the cadet so the position is not affected when requiring these items during a course of fire. The table, chair or adjustable device must not act as an artificial support for the cadet.

KNEELING ROLL

A kneeling roll is placed under the right foot in the kneeling position. The kneeling roll is an optional piece of equipment and some cadets may find it improves comfort and stability in the kneeling position.

PHYSICAL TRAINING

Physical training improves and develops the strength and endurance required to hold the rifle steady for long periods of time without fatigue.

WARM-UP EXERCISES TO BE DONE BEFORE STATIC STRETCHING

Each exercise should last about 20-30 seconds and it is important not to bounce or jerk when doing them.



Neck

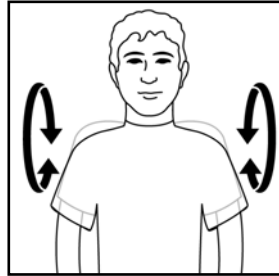

Shoulders

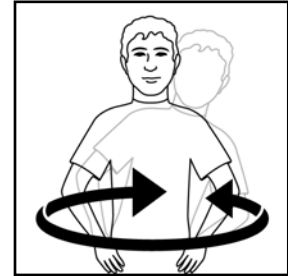

Trunk

STATIC STRETCHING EXERCISES

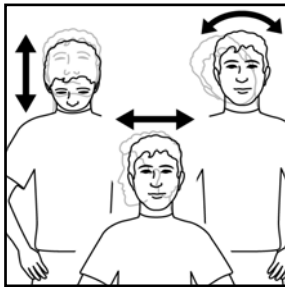

Head and neck



Shoulders, arms and wrists

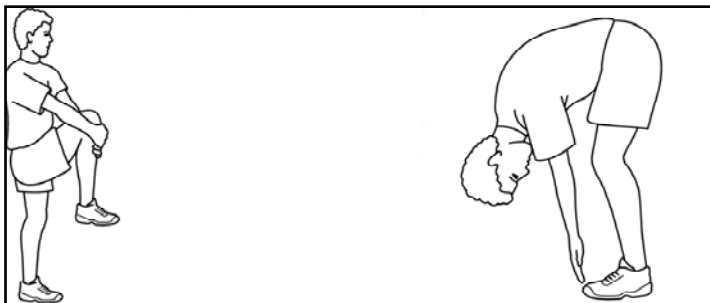
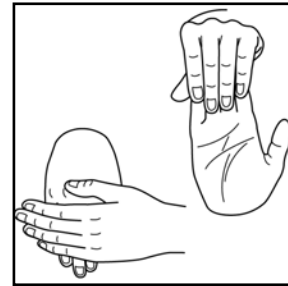

Back

Before a competition or practice, a warm-up exercise is recommended in order to get the blood flowing and the muscles tuned.

Stretching exercises can help the individual's flexibility and level of comfort during the firing session.

COACHING

DUTIES OF A COACH

The role of a coach is to aid, assist, teach and help improve a cadet's performance. A good coach is able to recognise and improve imperfections in position, holding and firing. The following are tasks commonly performed by coaches:

- a. Providing positive reinforcement;
- b. Instilling self-confidence;
- c. Correcting marksmanship principles and techniques;
- d. Correcting position problems;
- e. Maintaining a coaching diary; and
- f. Analyzing targets.

ANALYSIS OF COMMON ERRORS

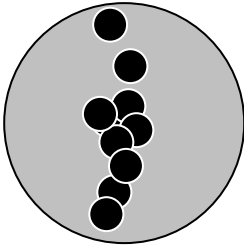

Improper position of the buttplate
Variance in breathing
Variance in eye relief

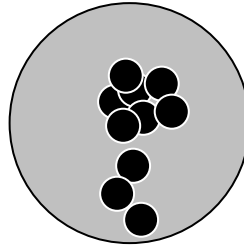

Sling slipping
Left hand moving forward

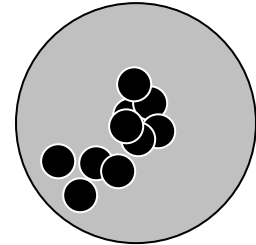

Anticipation of recoil

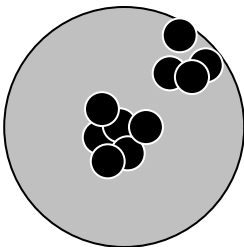

Anticipation of recoil

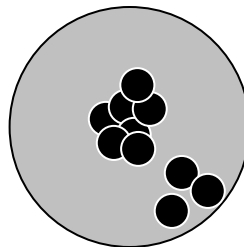

Jerking the trigger

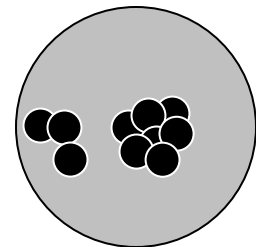

Squeezing the trigger at an angle
Improper usage of the sling

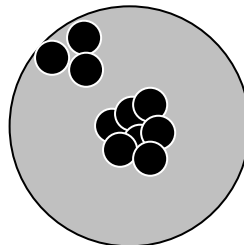

No follow-through or anticipation